



# Installation Guide

- A** Substructure Installation
- B** Aspira Deck Board Installation
- C** Aspira Plus Deck Board Installation
- D** Delta Deck Board Installation
- E** Vista/Innova Deck Boards Installation

# Contents

<b>Introduction</b>	
Tools and Equipment .....	3
Health and Safety Equipment.....	4
<b>A Substructure Installation</b>	
BoxRail and Cleat Substructure System.....	5
<b>B Aspira</b>	
Decking Board Installation .....	8
<b>C Aspira Plus</b>	
Decking Board Installation.....	10
<b>Aspira Accessories</b>	
Drainage Channel installation .....	12
Edge Support Trim.....	13
<b>D Delta</b>	
Decking Board Installation .....	14
Drainage Channel installation (Delta30 only) .....	15
<b>E Vista/Innova</b>	
Decking Board Installation.....	16
<b>F FAQ's</b>	
.....	18
<b>G Care and Maintenance</b>	
.....	19



For further information:

T: +44 (0)3300 94 94 11

E: sales@mydek.com

[www.mydek.com](http://www.mydek.com)

# Introduction

Welcome to your MyDek installation guide. This guide has been produced to facilitate successful installation of your aluminium deck system.

As with any successful project, having the right tools for the job is an essential part of success and we've listed some recommendations below:

## Tools and Equipment List



### Circular Saw/ Chop Saw

with blade for cutting aluminium

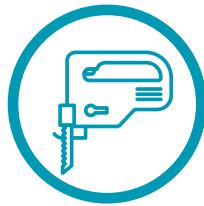

### Jigsaw

with blade for cutting aluminium



### Pencil

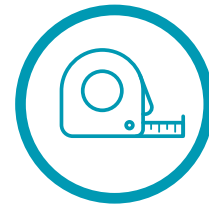

### Tape measure



### Spirit level/ Laser level

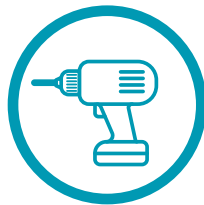

### Cordless drill or screwdriver

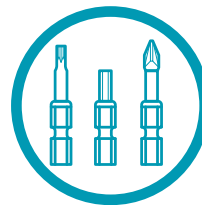

### Driver bits:

- Long shank T15 Torx bit (Vista and Innova systems)
- 8mm Hex driver (delta boards and Box rails systems)
- PZ2 Driver for end cap and edge trim screws



### Vacuum cleaner

for dust/filings extraction



Warning - do not use an impact driver, as they can exert excessive forces on the fixings, causing them to fail.



Screws should be tightened to a maximum torque of 2Nm.

For further information:

T: +44 (0)3300 94 94 11

E: sales@mydek.com

www.mydek.com



## Minimum Health and Safety Equipment



**Goggles or  
safety glasses**



**Gloves**

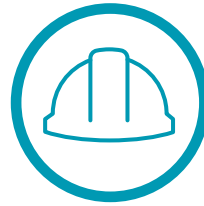

**Hard Hat**



**Safety boots**

## Important!

Cutting aluminium produces swarf and sharp filings. Additionally, cut edges can be sharp. Always ensure you wear suitable protective clothing and thoroughly remove any burrs caused by cutting.

Note, this installation guide assumes that the area is subjected to standard residential floor loadings for balconies (EN 1991-1-1:2002 Table 6.1 Category A-Balconies). Where higher loadings are required, e.g. for public terraces, BoxRails need to be set out with closer spacings. Please contact MyDek Technical Support if higher loadings are required for advice on correct setout.



For further information:

T: +44 (0)3300 94 94 11

E: [sales@mydek.com](mailto:sales@mydek.com)

[www.mydek.com](http://www.mydek.com)

# A Substructure Installation

## BoxRail™ and Cleat Substructure System

1. Plan and set out the balcony area with **BoxRail™** joists placed loosely at the correct spacings to accept the decking.

Ensure that there are joists close to the ends of the decking boards to provide support (preferably not more than 150mm cantilever at the end of board)



60 x 40mm **BoxRail™** rails should be spaced at maximum 600mm (950mm if using **Aspira**, 1000mm if using **Delta30**) apart with cleats spaced using the table below.

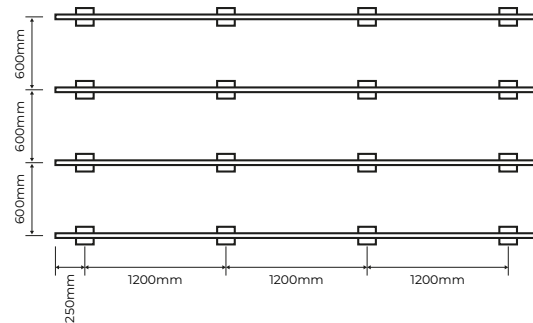

2. Set out a cleat foot at each point required using appropriate spacings along the length of the **BoxRail™**, using the table below.

BoxRail height	Max Cleat Spacing	Max Overhang
32mm	900mm	200mm
60mm	1200mm	300mm
90mm	1800mm	500mm



**Caution!** When installing cleats on waterproofing membranes, MyDek recommends installing rubber protection mats under each cleat. Consider carefully whether additional metal spreader plates may be required. MyDek cannot be held responsible for any damage to waterproofing caused by insufficient protection.

For further information:

T: +44 (0)3300 94 94 11

E: sales@mydek.com

www.mydek.com



- 3.** Clip the first cleat foot onto one end of the **BoxRail™** and adjust to approximately the right height.

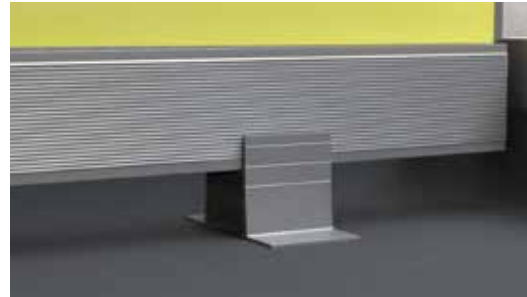

- 4.** Repeat at the other end. Place the **BoxRail™** carefully into position at one edge of the balcony and check level. Adjust the **BoxRail™** in the feet till a level position is achieved.



- 5.** Fit additional feet at approximate spacings in between the first and last foot, and adjust for height.



- 6** Using the groove as a positioning guide position 2 screws approx. 30mm apart to each side using the self drilling screws provided and fix through each cleat foot into the **BoxRail™**.



Warning - do not use an impact driver, as they can exert excessive forces on the fixings, causing them to fail.



Screws should be tightened to a maximum torque of 2Nm.



For further information:

T: +44 (0)3300 94 94 11

E: sales@mydek.com

[www.mydek.com](http://www.mydek.com)

- 7.** Repeat steps 3-5 on the other joists positions, levelling each joist with the previous one to maintain a level structure for the decking.



- 8.** Install decking as per Decking Installation Guide, later in this manual.



Max overhang of board:	
Aspira/Aspira Plus:	300mm
Innova	200mm
Vista	200mm
Delta 20	200mm
Delta 30	350mm

**IMPORTANT NOTE!**

**MyDek** decking systems are lightweight, however any live and permanent loads will be transferred through the pedestals/supports and can impose significant point loads. Consideration should be given to the terrace surface to ensure;

- i. The structure is sufficiently strong and robust to accept the expected loads without undue deflection
- ii. Any waterproofing membrane will not be damaged by the proposed point loads throughout its design live. (please consult manufacturers guidance)
- iii. The surface is smooth enough to ensure full contact between baseplate and surface.

Should there be any concerns, consideration should be given to either providing spreader plates under the supports, or reducing the support centres. **MyDek** offer a range of spreader plates and can offer advice on indicated expected loads on request.

For further information:  
T: +44 (0)3300 94 94 11  
E: sales@mydek.com

[www.mydek.com](http://www.mydek.com)



## B Aspira

### Decking Board Installation

1. Fix **Basic Clips** to the starting ends of the rails using the self drilling screws provided. T15 long shank driver bit required. Insert screws about half way only.



2. Insert the first board into the clips and check that all the **BoxRails™** are correctly aligned. Tighten the screws completely.



3. Place the **Basic Clips** up to the edge of the board. Insert a fixing screw about half-way.



Warning - do not use an impact driver, as they can exert excessive forces on the fixings, causing them to fail.



Screws should be tightened to a maximum torque of 2Nm.



For further information:

T: +44 (0)3300 94 94 11

E: sales@mydek.com

[www.mydek.com](http://www.mydek.com)



4. Lay the second board up to the row of clips and place the next row of clips up to the edge of the board and insert screws half-way.

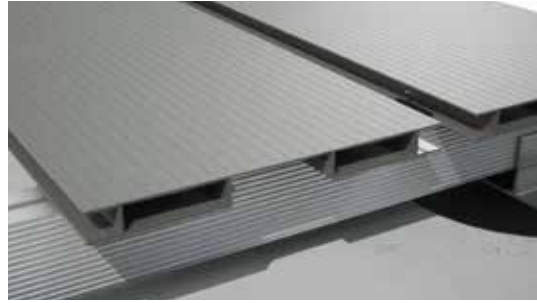

5. Tighten the previous row of fixings to fully secure the first board.



6. Place the next board up to the row of loose fixings, followed by the next set of clips and screws as in step 5. Repeat until all boards have been laid.



Warning - do not use an impact driver, as they can exert excessive forces on the fixings, causing them to fail.



Screws should be tightened to a maximum torque of 2Nm.

For further information:

T: +44 (0)3300 94 94 11

E: [sales@mydek.com](mailto:sales@mydek.com)

[www.mydek.com](http://www.mydek.com)



# C Aspira Plus

## Decking Board Installation

1. Position the board in the correct location and fix into position using the **MyDek** self-drilling screws and washers provided.





2. Tap the infill channel into position using a rubber mallet.

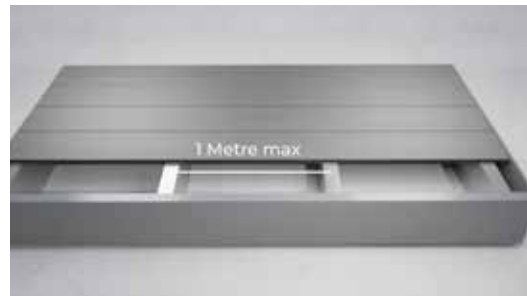

Supports should be spaced at maximum 1000mm for **Aspira Plus**.

**NOTE:** Where boards are being fixed to a rigid substrate (for example a steel balcony) allowance must be made for thermal expansion by predrilling an 8mm hole in the base of the board at each fixing position, and leaving a min 3mm gap between board ends on runs in excess of 12 metres.



 **Warning - do not use an impact driver, as they can exert excessive forces on the fixings, causing them to fail.**

 **Screws should be tightened to a maximum torque of 2Nm.**



For further information:

T: +44 (0)3300 94 94 11

E: [sales@mydek.com](mailto:sales@mydek.com)

[www.mydek.com](http://www.mydek.com)

- 3.** Position the next board leaving a gap of 6mm (tip: using 6mm spacing packers makes this job quick and easy).



Repeat until the area is decked completely.



#### **IMPORTANT!**

Once decking is installed, carefully clean the deck surface with a clean soft brush and if necessary a damp cloth to remove all swarf and dirt. Cover the deck completely with a protective layer e.g. correx board to protect from being scratched or damaged if further works are taking place around the balcony or terrace area prior to normal use. Only remove the protective layer once all construction work is complete and the decking is ready for normal use.

For further information:

**T: +44 (0)3300 94 94 11**

**E: [sales@mydek.com](mailto:sales@mydek.com)**

**[www.mydek.com](http://www.mydek.com)**



# Aspira Accessories installation

## Drainage Channel installation (Aspira)

1. Align the drainage channel section against the edge of the deck board as shown and fasten the screw into place.



2. Take the next deck board and align onto the other side of the drainage channel.



3. Tighten the screw using a screwdriver.

**Note:** Where lengths of channel need to be jointed, these should ideally be positioned where dripping does not cause a nuisance . A waterproof sealant may be possible using a proprietary sealant . Ensure a continuous bead between the two parts and remove any excess when pressed together to ensure a neat joint .

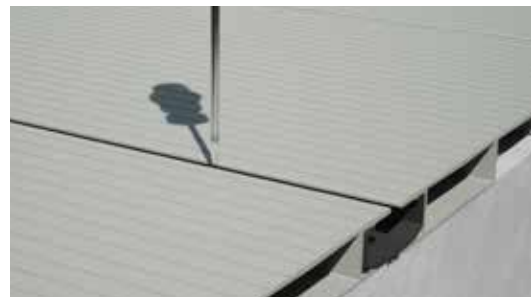

Warning - do not use an impact driver, as they can exert excessive forces on the fixings, causing them to fail.



Screws should be tightened to a maximum torque of 2Nm.



For further information:

T: +44 (0)3300 94 94 11

E: [sales@mydek.com](mailto:sales@mydek.com)

[www.mydek.com](http://www.mydek.com)

# Aspira Accessories installation

## Edge Trim installation (Aspira and Aspira Plus)

- 1 Create mitre joint by cutting the end edge trim first.

**Note**, the bottom of the edge trim will protrude slightly due to the support flanges - this is normal and can be fixed in this position. It is suggested that a small trial mitre is prepared to check fit.



- 2 Cut the mitre to the second trim, ensuring it is cut 2mm longer to allow the mitre to be closed effectively.



- 3 Fix mitre using colour coded screws provided through the top of the trim.



Warning - do not use an impact driver, as they can exert excessive forces on the fixings, causing them to fail.



Screws should be tightened to a maximum torque of 2Nm.

For further information:

T: +44 (0)3300 94 94 11

E: [sales@mydek.com](mailto:sales@mydek.com)

[www.mydek.com](http://www.mydek.com)



# D Delta20 and Delta30

## Decking Board Installation

1. Position the board in the correct location and fix into position using the **MyDek** self-drilling screws and washers provided.

Supports should be spaced at maximum 600mm for **Delta20** and 1000mm for **Delta30**.



**NOTE:** Where boards are being fixed to a rigid substrate (for example a steel balcony) allowance must be made for thermal expansion by predrilling an 8mm hole in the base of the board at each fixing position, and leaving a min 3mm gap between board ends on runs in excess of 12 metres.

2. Position the next board leaving a gap of 6mm (tip: using 6mm spacing packers makes this job quick and easy).

Repeat until the area is decked completely.



3. Once all boards are fixed, tap the capping channel into position using a rubber mallet.

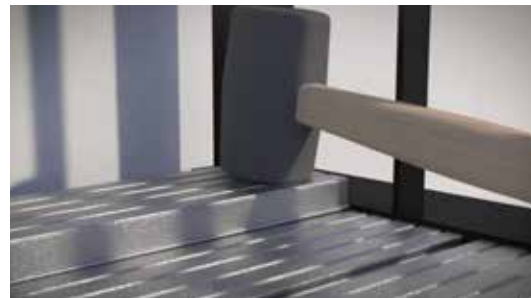

### IMPORTANT!

Once decking is installed, carefully clean the deck surface with a clean soft brush and if necessary a damp cloth to remove all swarf and dirt. Cover the deck completely with a protective layer e.g. correx board to protect from being scratched or damaged if further works are taking place around the balcony or terrace area prior to normal use. Only remove the protective layer once all construction work is complete and the decking is ready for normal use.



**Warning - do not use an impact driver, as they can exert excessive forces on the fixings, causing them to fail.**



**Screws should be tightened to a maximum torque of 2Nm.**



For further information:

T: +44 (0)3300 94 94 11

E: [sales@mydek.com](mailto:sales@mydek.com)

[www.mydek.com](http://www.mydek.com)

# Accessories installation

## Drainage Channel installation (Delta30 only)

1. Align and insert the drainage channel section as shown and push it firmly into position so that it nests completely against with the deck board profile.

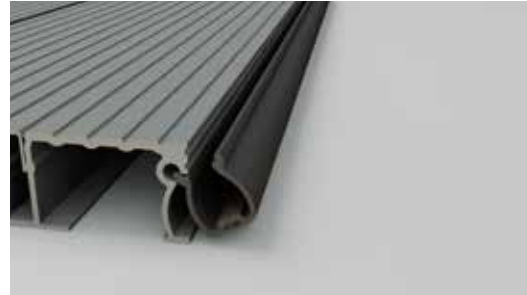

2. Take the next deck board and clip into the top edge of the drainage channel extrusion.

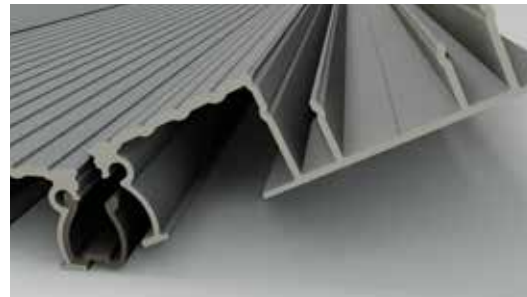

3. Push the deck down to the horizontal position ensuring that the two profile nest neatly as shown.

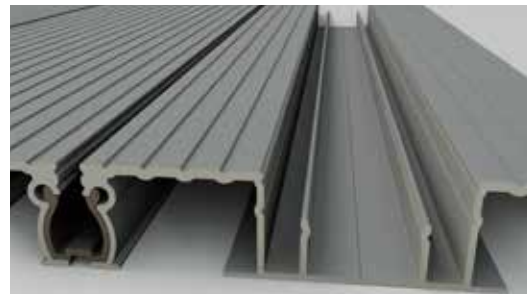

**Note:** Where lengths of channel need to be jointed, these should ideally be positioned where dripping does not cause a nuisance. A waterproof sealant may be possible using a proprietary sealant. Ensure a continuous bead between the two parts and remove any excess when pressed together to ensure a neat joint.

For further information:

T: +44 (0)3300 94 94 11

E: [sales@mydek.com](mailto:sales@mydek.com)

[www.mydek.com](http://www.mydek.com)



# E Vista/Innova

## Decking Board Installation

1. Fix **Basic Clips** to the starting ends of the rails using the self drilling screws provided. T15 long shank driver bit required. Insert screws about half way only.



2. Insert the first board into the clips and check that all the **SupportRails™** are correctly aligned. Tighten the screws completely.



3. Place the **Basic Clips** up to the edge of the board. Insert a fixing screw about half-way.



Warning - do not use an impact driver, as they can exert excessive forces on the fixings, causing them to fail.



Screws should be tightened to a maximum torque of 2Nm.



For further information:

T: +44 (0)3300 94 94 11

E: sales@mydek.com

[www.mydek.com](http://www.mydek.com)



- 4.** Lay the second board up to the row of clips and place the next row of clips up to the edge of the board and insert screws half-way.

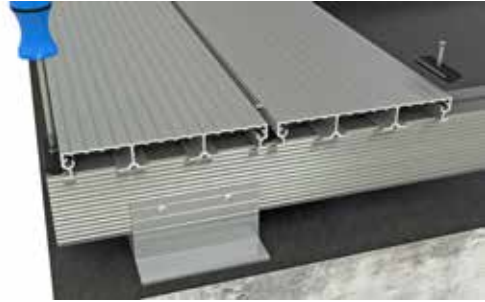

- 5.** Tighten the previous row of fixings to fully secure the first board.

- 6.** Place the next board up to the row of loose fixings, followed by the next set of clips and screws as in step 5. Repeat until all boards have been laid.

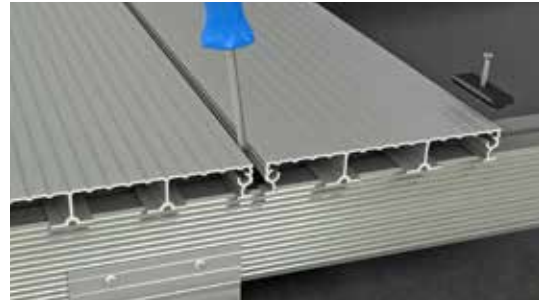

- 7.** If the last board is not a full width. Fit the snap-on clip taking care to position it so that locates exactly between two "legs" of the aluminium boards. [use this image currently showing for 6. Cut the last board to fit (to edge of balcony or into doorways as necessary) using appropriate metal-cutting blades in suitable power tools.



Slot the edge of the under the last clip and press the board down over the snap-on clip to fix in place. Tighten the screw on the clip between the last two boards to clamp firmly in position.

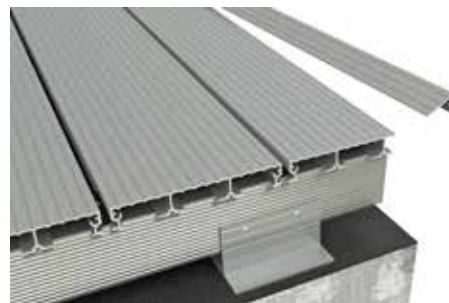

**Warning - do not use an impact driver, as they can exert excessive forces on the fixings, causing them to fail.**



**Screws should be tightened to a maximum torque of 2Nm.**

For further information:

T: +44 (0)3300 94 94 11

E: sales@mydek.com

www.mydek.com



## F FAQ's

- 1. Q. What are the maximum spans between the different boards?**  
A. Please see information on page 5.
  
- 2. Q. What is the maximum overhang from the last joist to the end of the board?**  
A. Please see table on page 7.
  
- 3. Q. What is the minimum construction depth of the sub-rail system.**  
A. This varies, but will be the height of the BoxRail, plus 3mm for the cleat foot and the board thickness
  
- 4. Q. What is the maximum depth that can be achieved.**  
A. Using the BoxRail system depths of up to 400mm can be achieved. Greater depths can be achieved using a platform build technique, details available on demand
  
- 5. Q. What is the maximum recommended joist overhang from a pedestal to the end of the joist.**  
A. Please see table on page 5.
  
- 6. Q. How do we remove any burrs caused by cutting?**  
A. Carefully remove any burrs using a flat file or medium grade abrasive paper.
  
- 7. Q. How do we repair minor scratches?**  
A. Using typical car body panel repair techniques, gently abrade the surface around the scratch using a fine grade abrasive paper remove any dust and contamination using a degreasing wipe. Spray the affected area using a acrylic spray paint at 30% gloss (sometimes called satin) finish.

All powders can show small colour and gloss differences from batch to batch, this is normal and unavoidable



For further information:

**T: +44 (0)3300 94 94 11**

**E: [sales@mydek.com](mailto:sales@mydek.com)**

**[www.mydek.com](http://www.mydek.com)**

## G Care & maintenance

Congratulations! You are lucky enough to have a **Mydek** Non-Combustible Decking System!

Your decking is made from aluminium and has been produced and tested to the highest standards of the industry. With simple and regular care will last many years to come. Aluminium will never burn, rot, rust or warp so you can relax in the knowledge that you are safe and sound.

Here's a few simple do's and don'ts to ensure your decking remains in optimum condition.



### Do:



Keep your deck free of dirt and debris by regular sweeping (at least every 2 weeks) with a soft brush.



Try to lift furniture or planters rather than drag them across the deck surface.



Check your decking carefully once a year to ensure no fixings are working loose, and simply tighten them using the appropriate driver bit if necessary.



Wash your deck down regularly with clean water and a mild detergent if required. We recommend a minimum of 2 times a year, although coastal areas may require more frequent cleaning. Clean, wet surfaces can be allowed to air dry or can be wiped clean with a soft cloth.



Use furniture with rubber or plastic feet to prevent unnecessary scratching of the decking surface.



*Use your balcony and deck safely and enjoy!*

For further information:

T: +44 (0)3300 94 94 11

E: [sales@mydek.com](mailto:sales@mydek.com)

[www.mydek.com](http://www.mydek.com)



## Don't:



Use sharp or abrasive materials to clean your deck (e.g. wire wool, abrasive papers or scrubbing tools). This may cause scratching of the coating which will affect the appearance.



Use furniture with metal feet which can scratch the decking if dragged across the surface.



Use abrasive salt grit for de-icing purposes. Instead, use easily soluble salt.



Use oil/wax sealants, coatings, or polishes on the decking as this may cause the surface to become slippery, especially when wet.



Use aggressive acid or alkaline chemical to clean your deck.

## If:

Your decking becomes damaged or scratched, [Contact Us](#) to ask for advice or to purchase a repair kit. Damaged deck boards may be removed and replaced if necessary but always check with your building manager or landlord if you live in a multi-occupancy apartment block. Mydek accepts no responsibility for the unsafe removal of deck boards from balcony environments.



For further information:

T: +44 (0)3300 94 94 11

E: [sales@mydek.com](mailto:sales@mydek.com)

[www.mydek.com](http://www.mydek.com)

For further information:  
**T: +44 (0)3300 94 94 11**  
**E: [sales@mydek.com](mailto:sales@mydek.com)**  
**[www.mydek.com](http://www.mydek.com)**



# About MyDek®?

The **MyDek** team harnesses a huge range of experience, creativity, passion and drive to make balconies and terraces safe places to be. Drawn from different areas of the construction industry our team brings together extensive knowledge of specification, technical compliance and outstanding innovation to create a non-combustible decking system that delivers on our mantra of Safe. Smart. Sustainable. **So relax, you're in safe hands.**

## Safe. Smart. Sustainable.

Our ethos runs through everything we do. We're passionate to ensure that our products reflect these values and make a significant contribution to residential balconies and terraces as safe and enjoyable places.

**Quite simply, you're going to love this.**

The philosophy that supports all our products



### Safe.

- Class A2-s1,d0 fire rated non-combustible aluminium
- Non-slip surface coating gives PTV rating of 59
- Durable alloy won't rust or rot
- 30 year warranty



### Smart.

- Attractive board design in range of colours
- Lightweight material reduces structural loads on buildings
- Fast fit system saves time and money on installation



### Sustainable.

- Made from recycled aluminium and is 100% recyclable.
- Low maintenance material gives 60 year service life
- Ready availability and easily recycled ensuring a low whole-life cost.

# MYDEK®

Non-combustible decking systems

For further information:

**T: +44 (0)3300 94 94 11**

**E: [sales@mydek.com](mailto:sales@mydek.com)**

**[www.mydek.com](http://www.mydek.com)**